



YDS CAMERA MODULE

your best camera partner

YDS-G1M9WF3+YDS-CMFL50101-IMX385 V1.0

Ai Master Board + WiFi Board + 2.13MP Sony IMX385 Fixed Focus Camera Module Development Kit

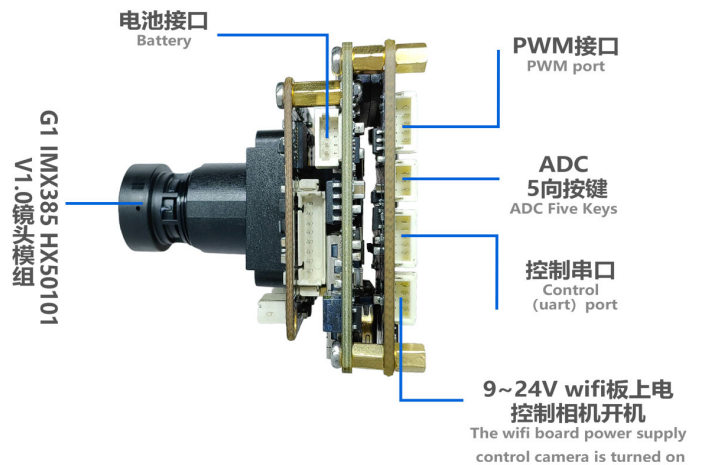
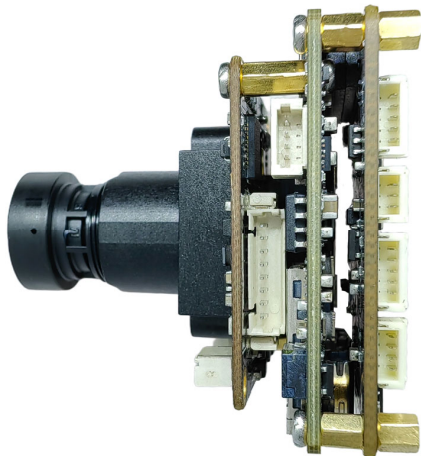
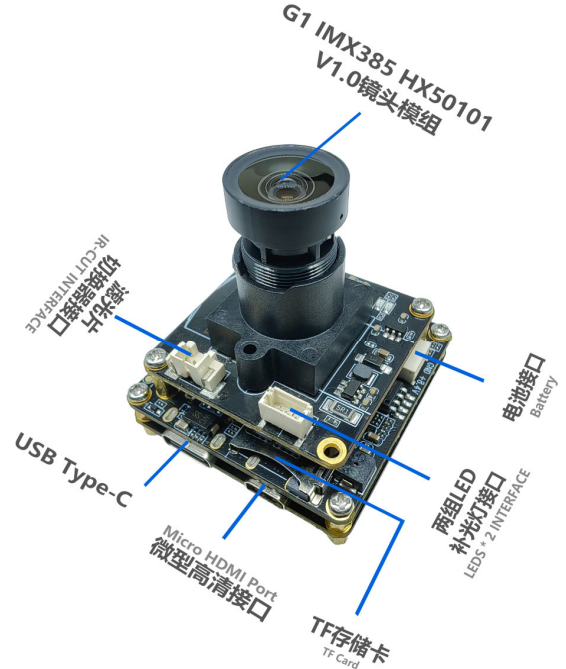

www.YDSCAM.com sales@ydscom.com Phone (WeChat, QQ): (+86) 177 2732 6718

All rights reserved @ YingDeShun Co. Ltd. Specifications subject to change without notice.

YDS-G1M9WF3+YDS-CMFL50101-IMX385 V1.0

Ai Master Board + WiFi Board + 2.13MP Sony IMX385 Fixed Focus Camera Module Development Kit

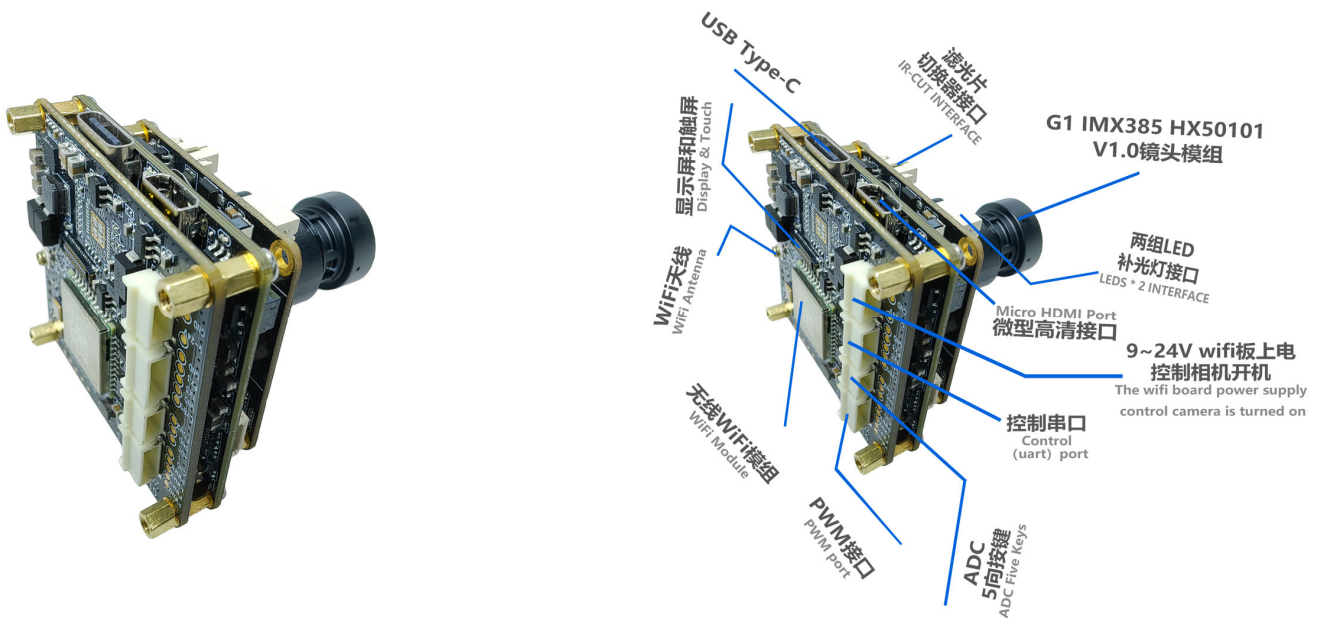

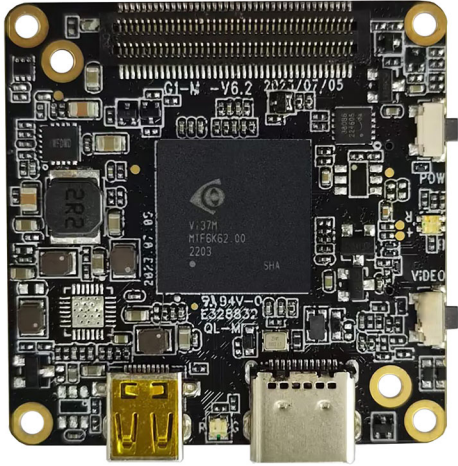
YDS-G1M9 V6.2**iCatch V39 Ai-Powered Image Processing SoC Master Board**

Front View

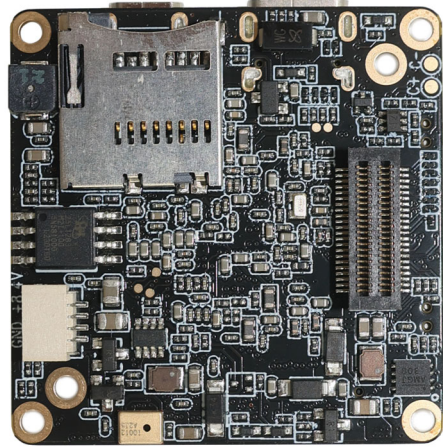

Back View

Overview

Equipped with iCatch V39, built-in 2GB DDR3, supports up to 4K@60FPS (differential), 4K@30FPS, 1080P@120FPS H.264 encoded video. Onboard support Type-C, HDMI, TF memory card, recording, 2 control buttons, buzzer, battery power supply, etc.

This master board extension also supports WiFi, LCD display, CVBS, lens module, UART, I2C, SPI, PWM, MIC and other expansion interfaces. The board size is 38x38mm. Widely used in drones, mini DV, wearable devices, sports cameras, face recognition, USB cameras and other camera products.



YDS-G1M9 V6.2

iCatch V39 Ai-Powered Image Processing SoC Master Board

Hardware Specifications

Model No.	YDS-G1M9 V6.2
Main Control Chipset (DSP)	iCatch V39
Image Sensor Interface	MIPI
Battery Voltage	7.4V - 7.7V High Voltage Lithium Battery
Storage Type	External TF Card, Supports 8GB - 512GB Class 10 and Above, U3 is Recommended
Type-C Port	Type-C USB 5V Connection to Computer USB Mode Connection to PCCAM (Camera) Mode
LED Indicator Type	Three Color Light (Red, Green, Blue)
2 Control Button Type	Power Button (A), OK Button (B)
Power Supply	Supports 3 Power Supply Methods At The Same Time (1) 5V USB to Type-C Port Power Supply (2) 9V-24V WiFi Board or Network Port board Power Supply (3) 6.8V-8.4V Battery Power Supply (The 3-Axis Gimbal Version Does Not Support 5V USB)
Operating Temperature	-10°C to +60°C Without Housing
Storage Temperature	-20°C to +80°C
Humidity	20% to 80%
PCB Dimensions	38 x 38 mm
PCB Screw Hole Spacing	External (34mm x4), Internal (28mm x2)
PCB Screw Hole Diameter	2 mm
Optional Camera Configuration	(1) YDS-G1M9 V6.2 + Camera (2) YDS-G1M9 V6.2 + Camera + YDS-G1WF V6.3 WiFi Board (3) YDS-G1M9 V6.2 + Camera + YDS-G1NK V6.3 Ethernet Board
Supportive Image Sensors	13MP: IMX258 12MP: IMX377 OS21D40 IMX577 IMX386 IMX378 8MP: IM317 5MP: IMX335 2MP: IMX290 IMX385
Optional Extension Ports	WiFi, Ethernet Network Port, Display, Audio IC, Lens Module, UART, I2C, SPI, PWM, MIC, etc.

YDS-G1M9 V6.2

iCatch V39 Ai-Powered Image Processing SoC Master Board

Photo Image Settings

Resolution	20MP, 13MP, 12MP, 10MP, 8MP, 5MP, 3MP, 2MP
Time Lapse Photography	OFF, 3S, 5S, 7S
Continuous shooting	OFF, 3-Shot, 7-Shot, 15-Shot, 30-Shot
White Balance	Auto, Sunny, Cloudy, Fluorescent, Incandescent
Power Frequency	50Hz, 60Hz
Exposure Compensation	EV 0.0, EV 3.0, EV 7.0, EV 10.0, EV 13.0, EV 17.0, EV 20.0, EV -3.0, EV -7.0, EV -10.0, EV -13.0, EV -17.0, EV -20.0
Time Lapse Photo Interval	OFF, 1S, 2S, 3S, 4S, 5S, 6S, 7S, 8S, 10S, 13S, 15S, 20S, 25S, 30S, 40S, 1min
Time Lapse Duration	No Limit, 1min, 3min, 5min, 10min, 20min, 30min, 1hr, 2hr, 3hr, 5hr
Photo Time Watermark	OFF, Date, Date and Time

Wifi、显示屏、网口、uart、PWM等扩展接口

For Wifi, Display, Network, uart, PWM Etc.

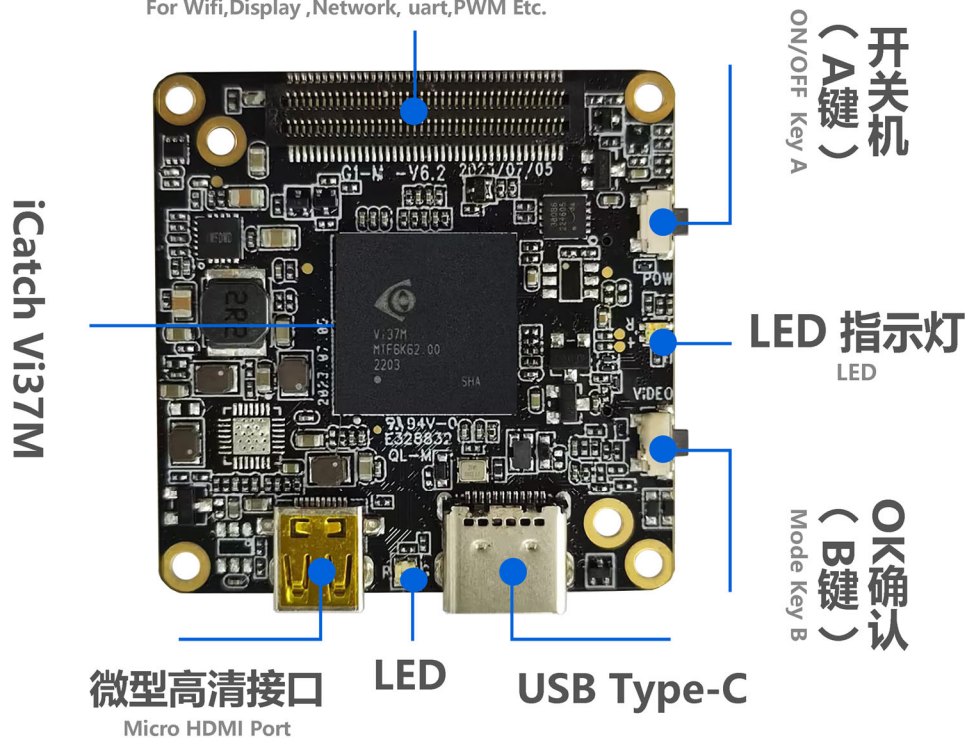



YDS-G1M9 V6.2

iCatch V39 Ai-Powered Image Processing SoC Master Board

Video Settings

Resolution	16:9 (4K, 2.7K, 1080P, 720P) 4:3 (1440P) Currently Only IMX377 Sensor Supports 1440P
Frame Rate	24FPS, 25FPS, 30FPS, 48FPS, 50FPS, 60FPS, 120FPS, 240FPS
Slow Motion Recording	OFF, 4K2X, 1080P4X, 720P8X
Fast Motion Recording	OFF, 2X, 5X, 10X, 15X, 30X
Automatic Recording	OFF, ON
Time Lapse Video Mode	OFF, 1S, 2S, 3S, 4S, 5S, 6S, 7S, 8S, 10S, 13S, 15S, 20S, 25S, 30S, 40S, 60S
Time Lapse Duration	No Limit, 1min, 3min, 5min, 10min, 20min, 30min, 1hr, 2hr, 3hr, 5hr
Pre-recording	OFF, ON (for Option ON, 5 Seconds of Video is Pre-recorded)
EIS Anti-Shake	OFF, ON
Image Quality Enhancement	Super Good, Very Good, Normal (Referral to Actual Video Effect Quality, Not for Preview)
Image Rotation	Normal, Vertical, Horizontal (for Recorded Video)
Recording Time	No Limit, 1min, 5min
Automatic Screen Off	OFF, 60S, 180S, 300S
Light Metering Mode	Center, Multi-point, Single Point
Video Recording File Time	No Limit, 1min, 5min
Loop Recording	OFF, ON
Recording Volume	0, 1, 2, 3
Video Time Watermark	OFF, Date, Date and Time



YDS-G1M9 V6.2

iCatch V39 Ai-Powered Image Processing SoC Master Board

System Settings

Automatic Shut Down	OFF, 1min, 3min, 5min, 10min, 15min
USB Auto Power On	Turn ON, Turn OFF
Languages	English, Simplified Chinese, Traditional Chinese (Select Language Through Configuration File in the Card)
Button Touch Tone	Turn ON, Turn OFF
Automatically Turn On WiFi	Turn ON, Turn OFF
WiFi Frequency Bands	2.4GHz or 5GHz (Dual Band Single Channel)
Display Brightness	Low, Medium, High Brightness (for Touch Screen)
Display Setting	Conventional Display, Full Screen Display (for Touch Screen)
Fill Light A (White Light)	Auto, OFF, ON (for Use with Fill Light Board)
Fill Light B (Infrared Light)	Auto, OFF, ON (for Use with Fill Light Board)
IR Cut Settings	Auto, OFF, ON (for Use with IR Cut Function Modules)
Special Effects	Original Image, Black and White, Natural, Negative, Warm Tones, Contrast (for Touch Screen)
White Balance	Auto, Sunny, Cloudy, Fluorescent, Incandescent
Date and Time	Year, Month, Day, Hour, Minute
Format	No, Yes
Reset	No, Yes
Card Information	Displays Video Card Capacity and Free Space
Device Information	Displays Firmware Version

Gimbal Functions and Settings

Gimbal Functions	Centering, Calibration
Sensitivity	Follow Softly, Follow Sensitively
Follow Mode	Full Follow, Heading Follow, Heading and Pitch Follow
Pitch Axis Control	Turn ON, Turn OFF



YDS-G1M9 V6.2

iCatch V39 Ai-Powered Image Processing SoC Master Board

Camera Features

Continuous Shooting	Long Press the OK Button (B) to Shoot Continuously, Release Button to Stop Shooting Continuously
Snapshot	During Recording, Long Press the OK Button (B) to Capture the Video. Release Button to Stop Snapshot
HDMI Output Resolution	4K@30FPS 1080P@60FPS/30FPS 720P@60FPS
Video Start and Stop Function	Short Press the Power Button (A) to Pause or Continue Video Recording
USB Camera Resolution	H.264: 4K@30FPS, 1080P@120FPS, 720P@60FPS (Dependency on Sensor Type and UVC Protocol) MJPG: 5760x3240@10FPS, 4000x3000@10FPS 4K@30FPS, 1080P@30FPS, 720P@30FPS YUY2: 480P@30FPS (Supports Modification of UVC Output on Configurations)
USB Flash Drive	USB Mode when Connected to Computer
Inverted Mode	By Placing a Configuration File in the Card, You Can Modify the Displayed or Captured file and Flip it 180 degrees
WiFi Mode	AP Mode, STA Mode Set WiFi Mode by Putting Configuration Files in the Card or Enter the Menu to Set This Item Through the Touch Screen
Configuration IP Address	By Placing a Configuration File in the Card, You Can Modify the IP and Gateway Address of the Camera. Default is Static IP. Optional on Dynamic IP.
RTSP Video Stream Address	By Placing a Configuration File in the Card, You Can Modify the RTSP video stream address. If There is No Configuration File in the Card, the Default Port is 554.

YDS-G1M9 V6.2

iCatch V39 Ai-Powered Image Processing SoC Master Board

USB Type-C Interface:

This interface supports USB standard 5V power input, which can power the master board and charge the battery (recommended 7.4V-7.7V battery). Connecting to a computer can directly read files in the TF card and use it as a USB flash drive. It can also be used as a PCCAM USB camera.

The USB interface retains one camera control serial port UART3 and one camera debugging serial port UART1 (the serial port function can be used with the G1-USB serial port debugging board).

Connecting to the Computer USB Flash Drive Mode:

Insert the TF card, connect the other end of the USB to the computer, and automatically enter the USB flash drive mode after booting by default.

Connecting to the Computer PCCAM Mode:

Insert the TF card, connect the other end of the USB to the computer, and automatically enter the USB flash drive mode after booting. Short press the OK button (A) to switch to PCCAM camera mode. (Right-click the computer "Computer", click the left button in the pop-up prompt box to enter "Management", "Device Manager", and you can see the name of the camera identified in "Image Device" camera. Open the camera tool "amcap.exe" to see the current device preview screen).

Battery Power Supply:

6.6V (low power shutdown) to 8.8V, 7.4-7.7V high-voltage and high-density batteries are recommended
Special note: the battery power supply can support up to 12V; but this does not include the gimbal version, the stable power supply voltage of the gimbal version is 8V.

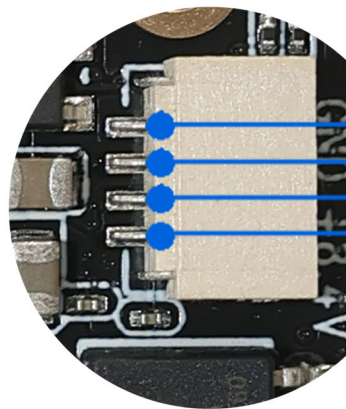
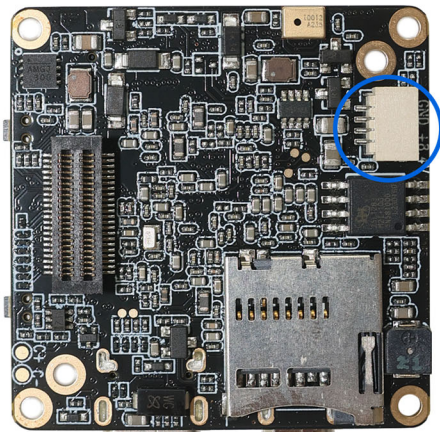

BAT -
BAT +

Battery 7.7V-8.8V

电池供电

YDS-G1M9 V6.2

iCatch V39 Ai-Powered Image Processing SoC Master Board

Charge the Battery:

Use a power adapter (5V2A recommended) to charge the battery of the machine. The red light will be on during charging and the green light will be on when fully charged.

Camera Module:

This interface can be used to expand multiple MIPI sensors, IR-CUT function, LED fill light, serial port UART2, battery power output, micro three-axis gimbal and other functions.

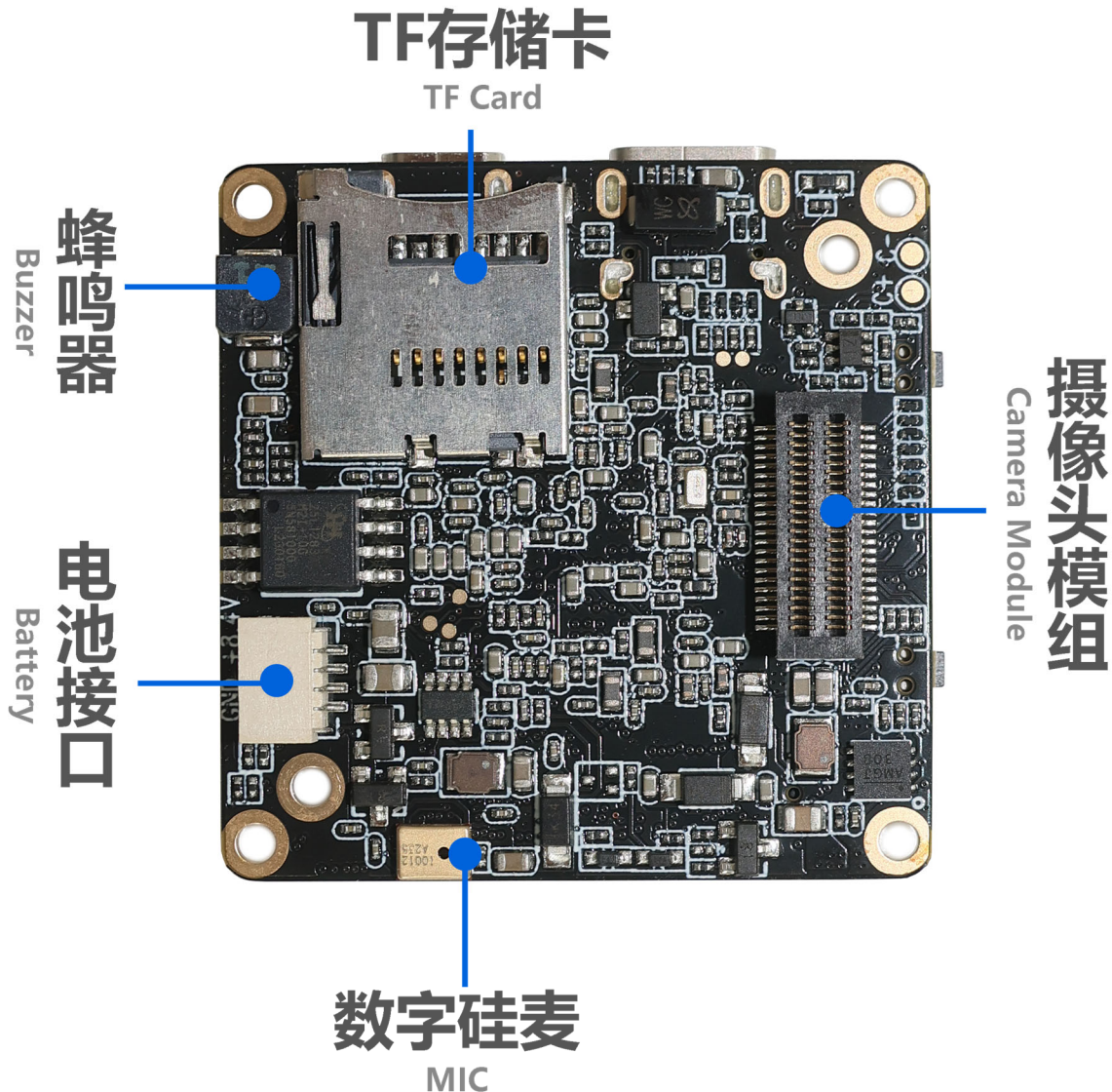



YDS-G1M9 V6.2

iCatch V39 Ai-Powered Image Processing SoC Master Board

Button Instructions:

Button	Mode or Status	Functional Operation
Button A Power Mode	Power ON / OFF	Long Press 1 Second Power ON / OFF
	Standby	Short Press on Switch Mode Video Recording, Snapshot, Playback, Settings
	Setting Mode (with Touch Screen)	Short Press to Scroll Down Menu (After Pressing Button B to Enter Setting)
	Video Recording	Short Press to Pause or Continue Recording
Button B Confirmation OK Video Recording	Standby	In Video Standby Mode, Long Press 3 Seconds to Turn ON / OFF WiFi Mode. Default WiFi is OFF. In Video Recording Mode, Short Press to Start Recording In Snapshot Mode, Short Press to Start Taking Photo Long Press to Start Continue Shooting Release to Stop Continue Shooting
	Video Recording	Short Press to Stop Recording and Save the File Long Press 2 Seconds (Less than 4 Seconds) to Take a Single Frame Shot, Release to Stop Taking Frame Shots Long Press 5 Seconds to Take Continues Frame Shots, Release to Stop Taking Frame Shots
	Setting Mode (with Touch Screen)	Short Press to Confirm and Enter Setting Mode Long Press 2 Seconds to Return Double-Click to Switch Between Settings: Photo / Video / System / 3-Axis Gimbal
	Playback Mode (with Touch Screen)	Short Press to Scroll Up Menu Double-Click to Play / Pause Video or Audio Files Click 3 Times to Mark or Unmark Files. If File is Marked, then the File is Locked and Not Erasable Long Press to Prompt Option to Delete Current File (Long Press to Delete, Short Press to Return) After Entering, Long Press Again to Delete
	Shutdown	Press and Hold to Enter the USB Burning Mode
Reset Function	Standby or Working	Press Button A and B at the Same Time to Shutdown



YDS-G1M9 V6.2

iCatch V39 Ai-Powered Image Processing SoC Master Board

LED Indicator Description:

Functions	Color	Power On	Video Mode	Video Recording	Photo Mode	Photo Snapshot	Playback Mode	Setting Mode
LED Indicator	Red	Always On	Always On	Flashing			Always On	
	Green				Always On	Flash Once	Always On	
	Blue						Always On	Always On

Note: When the device is powered without a TF card inserted, the function indicator light flashes yellow.

Buzzer Sound Description:

Operation Mode	Power On	Power Off	Switching Mode	Start Video Recording	Start Stop Recording	Photo Snapshot	Menu Setting	Menu Scroll Down	Exit Menu Setting
Buzzer Sound	3 Beeps	5 Beeps	1 Beep	1 Beep	2 Beeps	1 Beep	1 Beep	1 Beep	1 Beep

Special Note: When the touch screen is not in use, you can modify the setting parameters through the configuration file. Put the configuration file, such as "CameraConfig_G1A.ini" (the specific configuration file name will vary depending on the lens module) in the root directory of the TF card, and you can modify the corresponding function options in the configuration file. After saving the changes, shut down the machine and restart it to take effect.

YDS-G1WF V6.3 WiFi Expansion Board

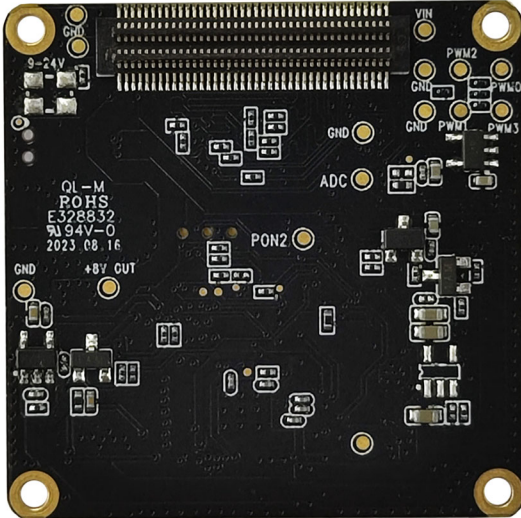

Front View

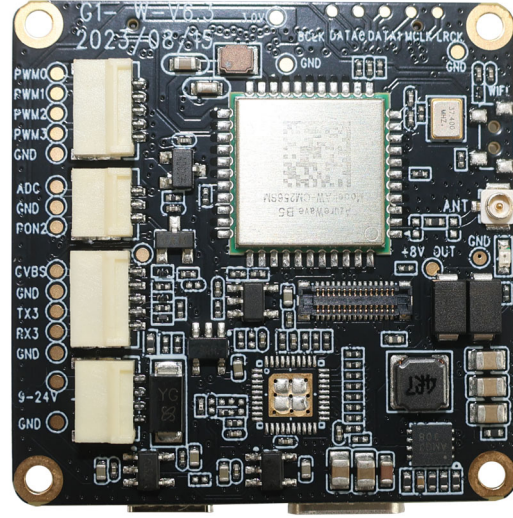

Back View

Overview

WiFi expansion board is equipped with the AW CM256SM single-pass dual-band WiFi module, which supports the use of single-band 2.4GHz or 5GHz wireless WiFi functions. The board supports WiFi antenna, reserved WiFi button (Button C), serial port (UART3), etc.

PWM, ADC button, touch screen and other expansion interfaces included. The board PCB size is 38x38mm, and it must be used with our company's designated master board. This WiFi board can not work independently.



YDS-G1WF V6.3 WiFi Expansion Board

Specifications

Model No.	YDS-G1WF V6.3
WiFi Module	AW CM256SM
Power Supply	Supports 3 Power Supply Methods At The Same Time (1) 5V USB to Type-C Port Power Supply (2) 9V-24V WiFi Board Power Supply (3) 6.8V-8.4V Battery Power Supply (The 3-Axis Gimbal Version Does Not Support 5V USB)
WiFi Frequency Bands	2.4GHz or 5GHz (Dual Band Single Channel)
Wireless Network Standards	IEEE 802.11B/G/N/AC, WiFi Compliant
2.4GHz Frequency Range	2.400GHz - 2.472GHz (2.4GHz ISM Band)
2.4GHz Channels	2.4GHz: Channel 1 - Channel 13
2.4GHz Transmission Rate	2 - 3 Megabytes
2.4GHz Transmission Distance	50 Meters (No Disruption)
5GHz Frequency Range	5.150GHz - 5.825GHz (5GHz ISM Band)
5GHz Channels	5GHz: Channel 1 - Channel 13
5GHz Transmission Rate	6 - 8 Megabytes
5GHz Transmission Distance	30 Meters (No Disruption)
CVBS (TV-Out)	720 x 576
CVBS Standards	NTSC / PAL (TV-Out)
Serial Port / UART	RX3, TX3, GND
ADC Button	Up, Down, Left, Right, OK 5-Way ADC Buttons Power Button
Operating Temperature	-10°C to +60°C Without Housing
Storage Temperature	-20°C to +80°C
Humidity	20% to 80%
PCB Dimensions	38 x 38 mm
PCB Screw Hole Spacing	34 mm
PCB Screw Hole Diameter	2 mm
Extendable Functions	PWM, ADC Buttons, WiFi Board Power Supply UART3 Serial Port, Touch Screen, Other Interfaces

YDS-G1WF V6.3 WiFi Expansion Board

Hardware Interface Function Description

AW CM256SM single-pass dual-band WiFi module supports single-band 2.4GHz or 5GHz wireless WiFi function, and adopts the first generation IPEX universal copper standard antenna.

In the video mode standby state, long press the master board Button B, that is, long press the motherboard shooting button for 3S to turn on WiFi. The red light flashes when WiFi is turned on, and the red light is always on after the connection is successful.

PWM接口
PWM port

无线WiFi模组
WiFi Module

ADC
5向按键
ADC Five Keys

控制串口
Control
(uart) port

WiFi天线
WiFi Antenna

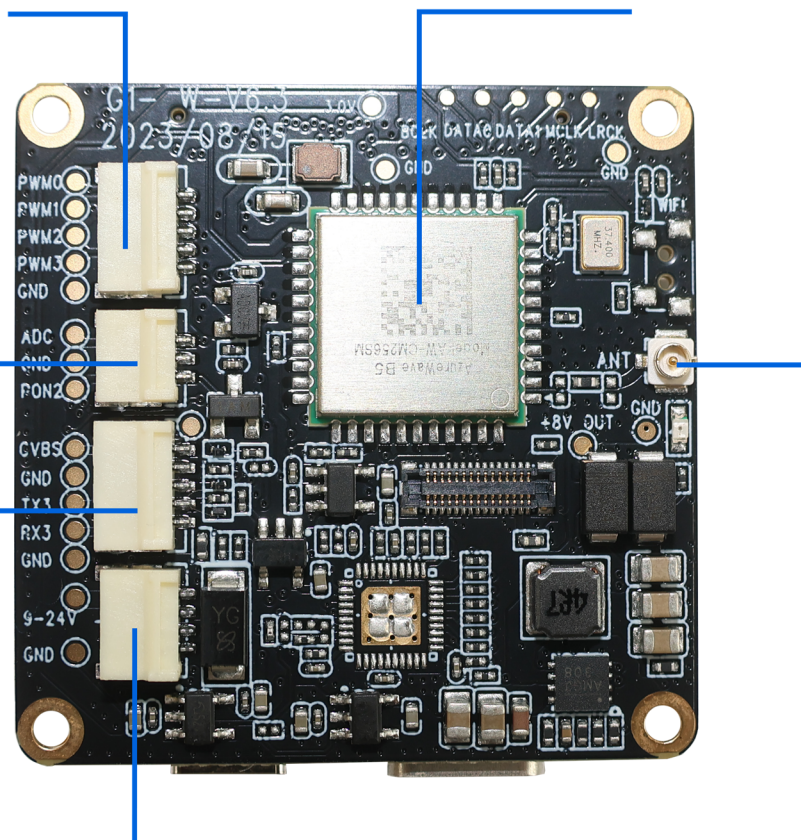

9~24Vwifi板上电控制相机开机

The wifi board power supply control camera is turned on

YDS-G1WF V6.3 WiFi Expansion Board

The PWM function interface, which can be used to control camera mode switching, photo taking, video recording and other functions.

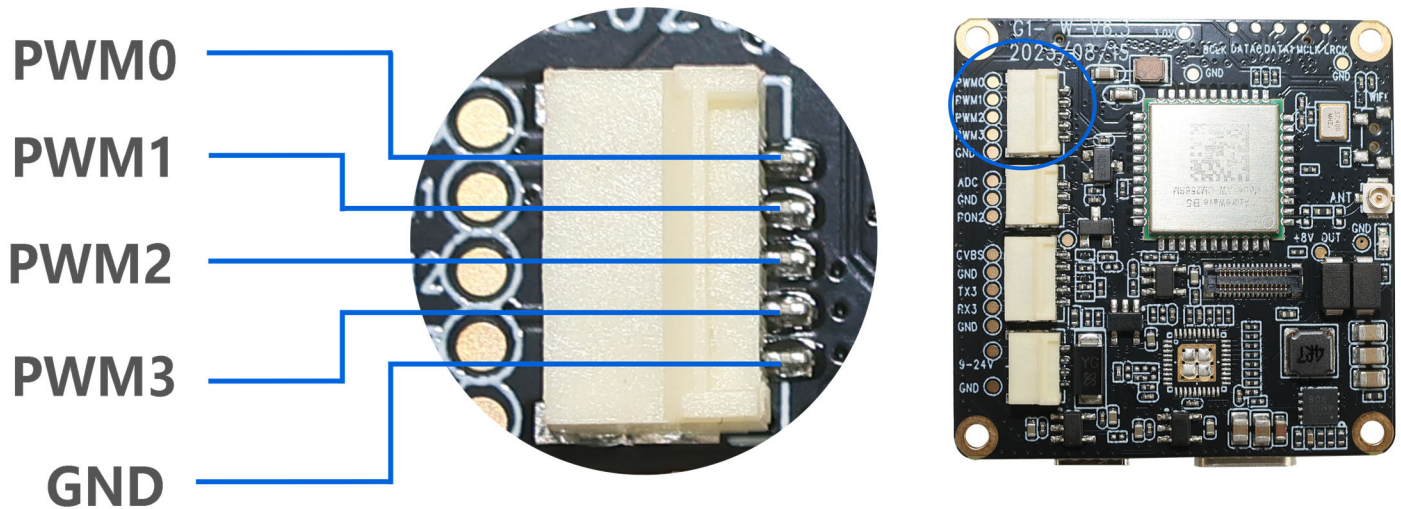

Supports one ADC button interface, which can be connected to five buttons: up, down, left, right, and OK, to control the camera's recording, taking pictures, turning on WiFi, etc. Supports external buttons to control the camera's power on and off.

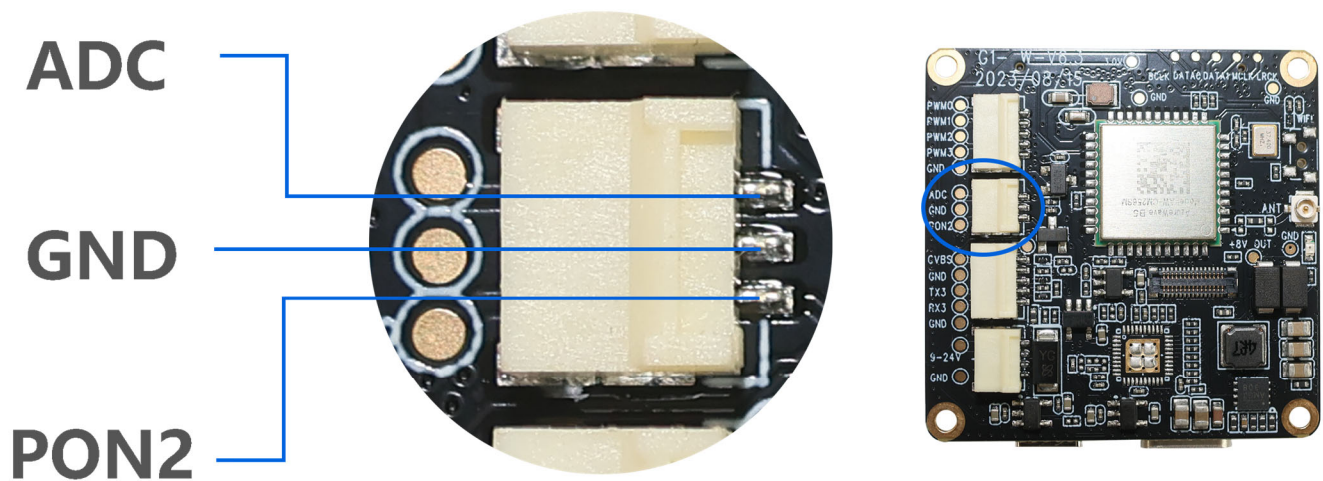

YDS-G1WF V6.3 WiFi Expansion Board

Supports one analog video CVBS (TV-OUT) signal output, with RX3 and TX3 reserved ports, and the camera can be set and controlled through this serial port.

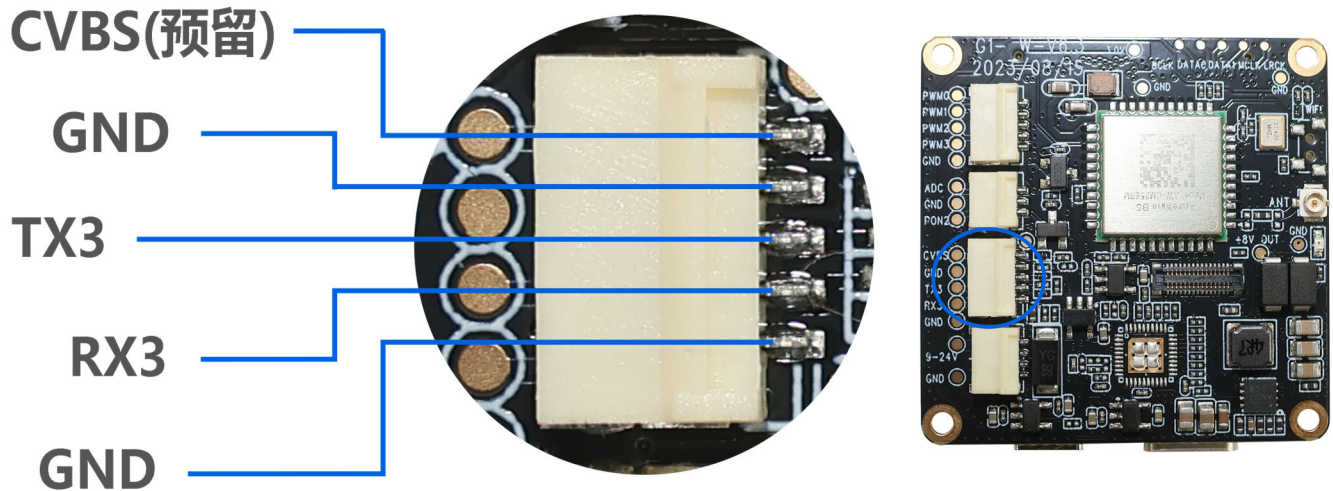

The camera can be powered on automatically using 9V-24V power supply; the master board supports three-way simultaneous use, namely WiFi board power supply, motherboard battery power supply, and Type-C USB power supply. It can also be used with a single power supply.

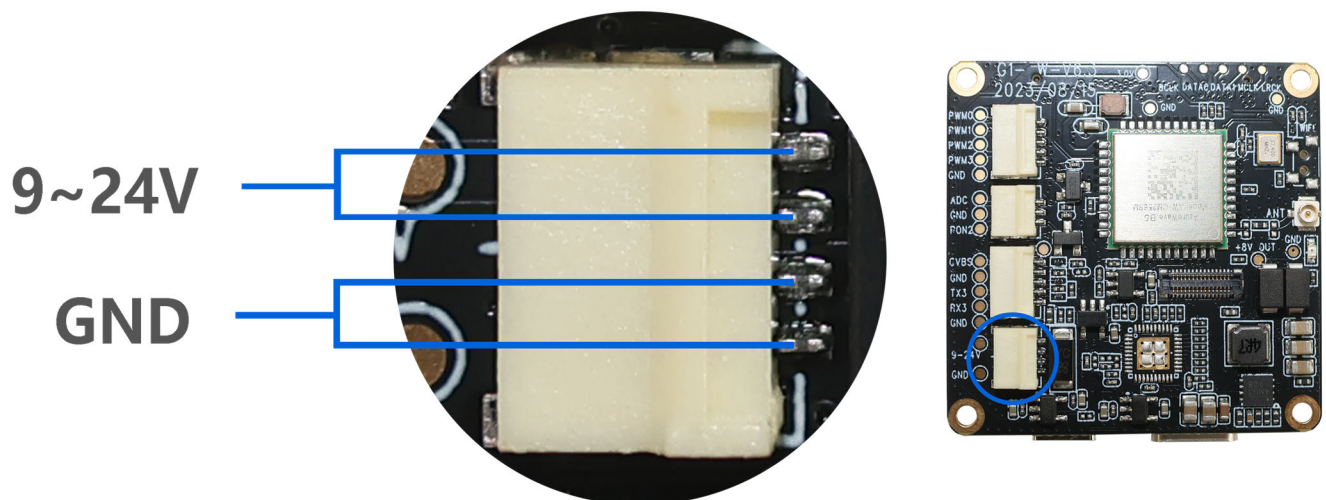

YDS-G1WF V6.3 WiFi Expansion Board

Special note:

The three-axis gimbal does not support 5V USB power supply alone. The battery power supply can support up to 12V; but this does not include the gimbal version, the stable power supply voltage of the battery for gimbal version is 8V.

wifi板连接主板扩展板接口 wifi board connect to main board

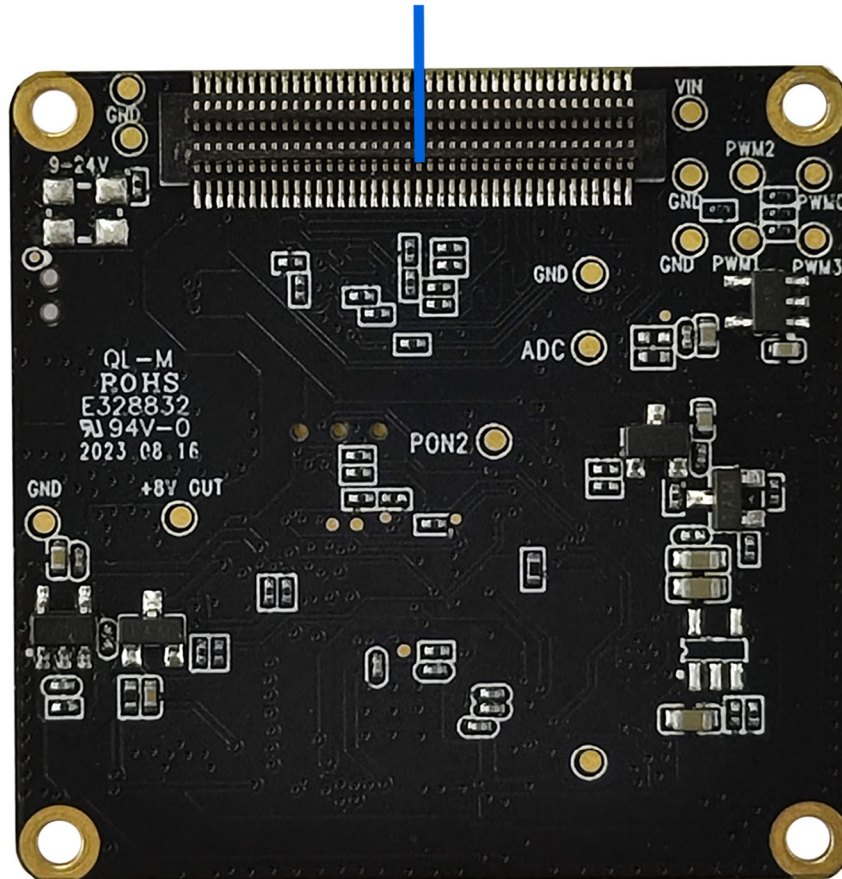

YDS-CMFL50101-IMX385 V1.0

2.13MP Sony IMX385 Fixed Focus Camera Module

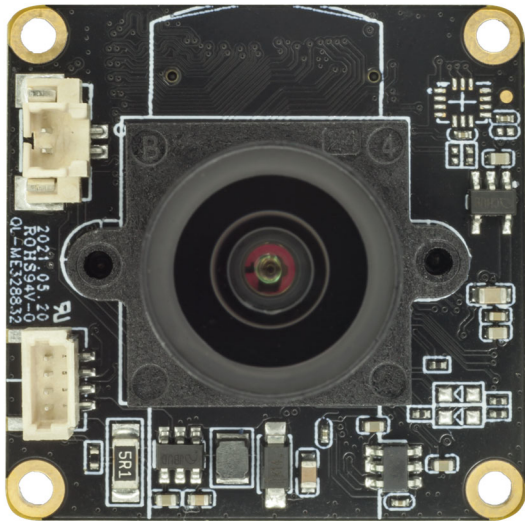

Front View

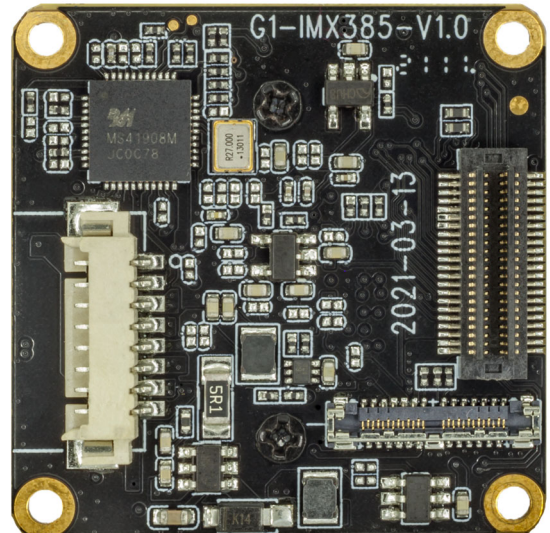

Back View

Overview

The YDS-CMFL50101-IMX385 V1.0 camera module uses the Sony IMX385 high-quality CMOS sensor, which has a diagonal of 8.35mm (1/2 type) CMOS image sensor, a pixel of 3.75um, a color square pixel arrangement, an effective pixel of 2.13 megapixels, super starlight-level photosensitivity, and a minimum illumination of low light color 0.001LUX, black and white 0.0002LUX. It can be used in low-light environments to even out the brightness of brighter and darker areas of the image.

When used with the master board, it can be used for local storage of low-light video shooting or USB UVC output, with the characteristics of true color restoration and excellent image quality.

The board frame size is 32x32mm, and the size from the top of the module lens to the PCB board is 32x32x28.24mm.



YDS-CMFL50101-IMX385 V1.0 2.13MP Sony IMX385 Fixed Focus Camera Module

Specifications

Model No.	YDS-CMFL50101-IMX385 V1.0
Image Sensor	IMX385
Image Sensor Type	CMOS
Effective Pixels	2.13 Megapixels
Sensor Size	1/2"
Pixel Size	3.75 um x 3.75 um
Video Frame Rate	1080P@30FPS/60FPS 720P@30FPS/60FPS/120FPS
Photo Resolution (with Master Board)	20MP (5200x3900) (Differential) 13MP (4160x3120) (Differential) 12MP (4000x3000) (Differential) 10MP (3648x2736) (Differential) 8MP (3264x2448) (Differential) 5MP (2592x1944) (Differential) 3MP (2048x1536) (Differential) 2MP (1920x1080)
Operating Temperature	-10°C to +60°C
Storage Temperature	-20°C to +80°C
Humidity	20% to 80%
PCB Dimensions	32 x 32 mm
Module Size	32 x 32 x 28.24 mm
PCB Screw Hole Spacing	28 x 28 mm
PCB Screw Hole Diameter	2 mm

YDS-CMFL50101-IMX385 V1.0 2.13MP Sony IMX385 Fixed Focus Camera Module

Lens Specifications

Lens Model No.	HX50101
EFL (Focal Length)	4.46 mm
TTL (Total Length)	22.27 mm
F. No.	1.65
Lens Barrel Thread	M12 x P0.5
Lens Construction	3G5P
Diagonal View Angle (DFOV)	123.5° (DFOV)
Horizontal View Angle (HFOV)	102.3° (HFOV)
Vertical View Angle (VFOV)	53.9° (VFOV)
Chief-Ray Angle	14.3°
Distortion	-46.50%
Relative Illumination	>48.3%
Lens Operating Temperature	-40°C to +85°C
Lens Storage Temperature	-40°C to +95°C

Lens Drawing

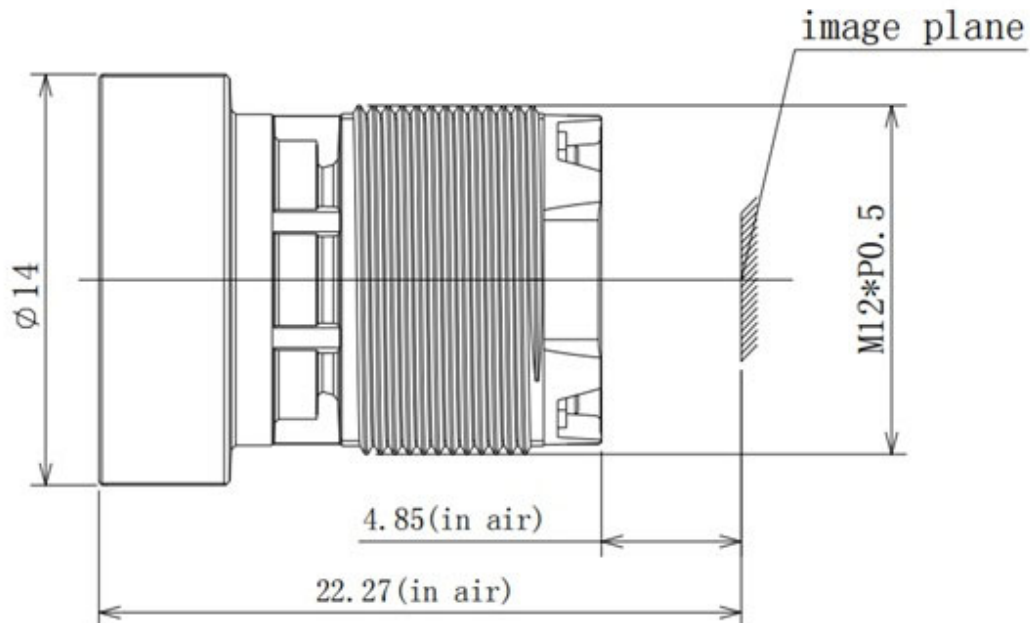

YDS-CMFL50101-IMX385 V1.0
2.13MP Sony IMX385 Fixed Focus Camera Module

IR-CUT INTERFACE
濾光片切换器接口

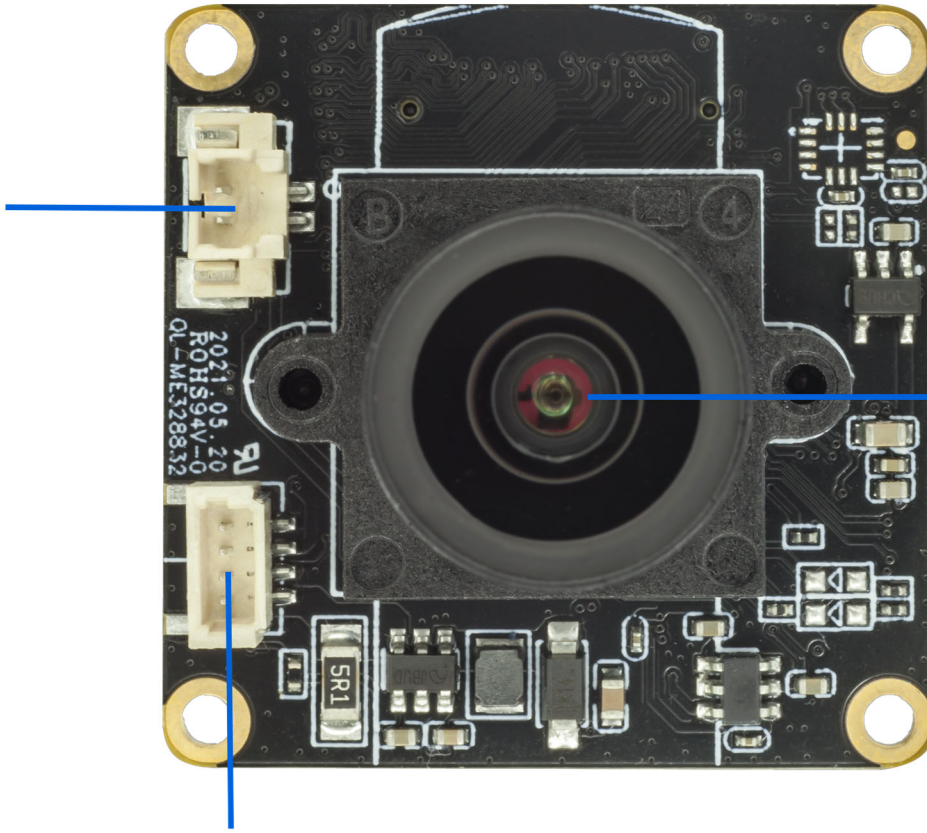

HX50101 镜头模组

两组LED补光灯接口
LEDS * 2 INTERFACE

Note: You can choose between TBT board-to-board socket or connecting to the master board via coaxial cable. Users can use them flexibly according to the construction scenarios.

YDS-CMFL50101-IMX385 V1.0 2.13MP Sony IMX385 Fixed Focus Camera Module

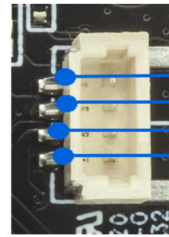
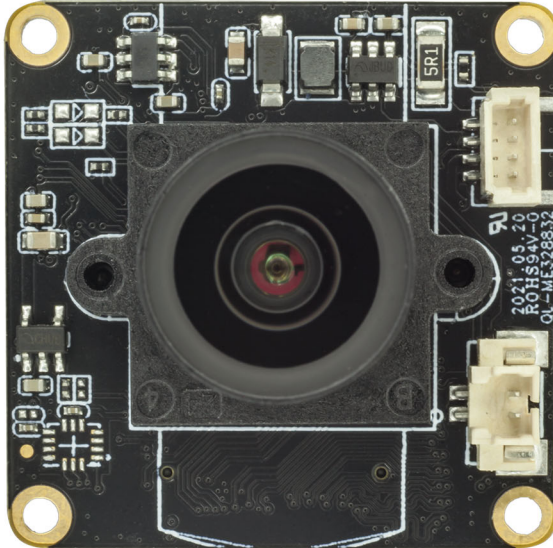

LED B -
LED B +
LED A -
LED A +

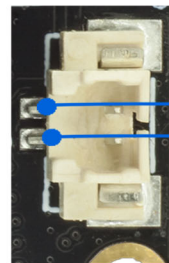

IR-CUT -
IR-CUT +

The two groups of fill light interfaces support the expansion of infrared lights and white light boards to provide fill light for the device. Note: The IR-Cut filter switch interface is used by lenses with filters, but this camera module does not support this function.

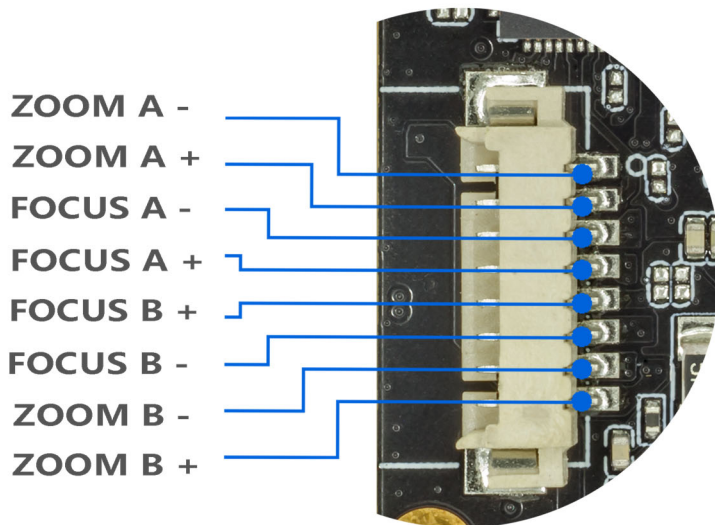

ZOOM A -
ZOOM A +
FOCUS A -
FOCUS A +
FOCUS B +
FOCUS B -
ZOOM B -
ZOOM B +

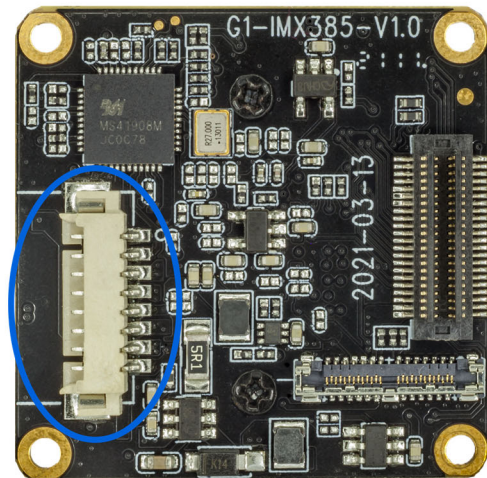

The auto focus interface leads to the connection automatically focusing motor to achieve the zoom function, but this camera module does not support zoom function.

YDS-CMFL50101-IMX385 V1.0 2.13MP Sony IMX385 Fixed Focus Camera Module

通过板对板连接器支持自动AF变焦镜头 Sensor、IR-CUT、LED等

Connect AF Zoom Lens, Sensor, IR-CUT, Led

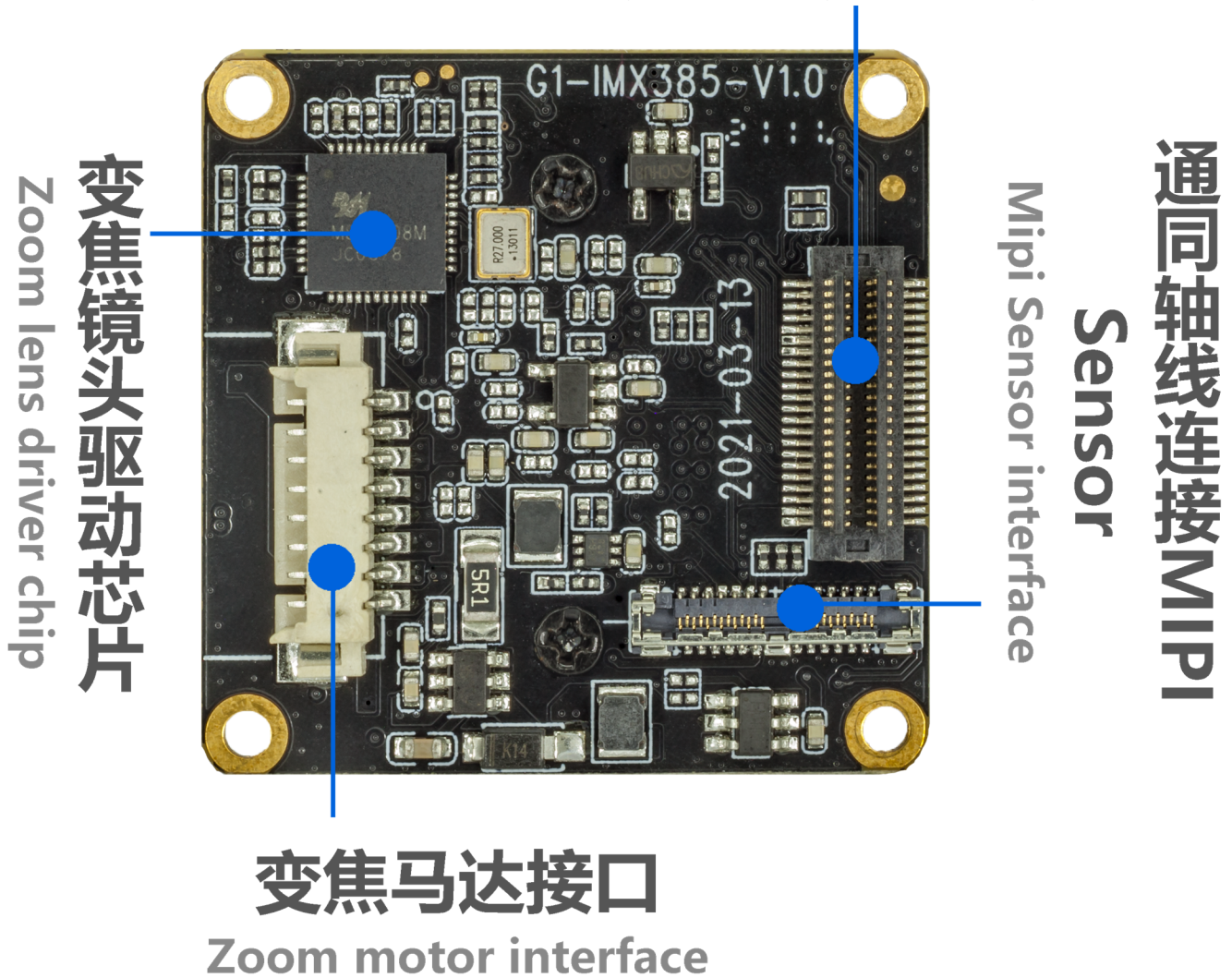

IMX385LQR

Diagonal 8.35 mm (Type 1/2) Approx. 2.13M-Effective Pixel
Color CMOS Image Sensor

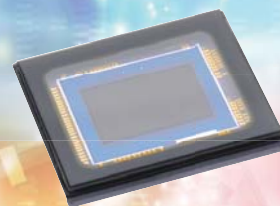

CMOS Image Sensor for Industrial Applications that Realizes High Sensitivity Approximately Twice That of the Existing Product

Sony Semiconductor Solutions Corporation has developed the CMOS image sensor "IMX385LQR" for industrial applications. This new image sensor realizes high sensitivity approximately twice that of the existing product (IMX185LQJ)*1.

The IMX385LQR pursues picture quality at low illuminance most needed by cameras for industrial applications and mounts pixels with a sensitivity of 2350 mV, which is the highest sensitivity among Sony image sensors for industrial applications*2. In addition, SNR1s of 0.13 lx*3, which is the highest performance among Sony Full HD-compatible image

sensors for industrial applications, is achieved by mounting an internal programmable gain amplifier and high conversion gain pixels. Superior performance as an image sensor for industrial applications is further achieved by combining HDR (High Dynamic Range) technology with technology that improves sensitivity in the near-infrared light region.

*1: See the New Product Information released in August 2013.

*2: As of January 2017 (based on in-house research)

*3: Low illuminance performance index advocated by Sony for image sensors for industrial applications

- High sensitivity characteristics using a new-generation 3.75 μm pixel (Sensitivity improved to approximately twice that of the existing product)
- Overwhelming low illuminance performance of SNR1s: 0.13 lx
- DOL-HDR function
- Versatile interface (Low-voltage LVDS serial, MIPI CSI-2)

Exmor

*Exmor is a trademark of Sony Corporation. The Exmor is a version of Sony's high performance CMOS image sensor with high-speed processing, low noise and low power dissipation by using column-parallel A/D conversion.

Overwhelming low illuminance performance

Cameras for industrial applications are required to produce color images with high picture quality even in dark conditions. High sensitivity characteristics of 2350 mV, which is approximately twice that of the existing Type 1/2 Full HD product (IMX185LQJ) with the same 3.75 μm pixel size have been achieved by mounting a new pixel with the highest sensitivity among Sony image sensors for industrial applications.

In addition, mounting high conversion rate pixels achieved SNR1s of 0.13 lx, which is the highest performance among Sony Full HD-compatible image sensors for industrial applications.

Furthermore, combination with technology for improving sensitivity in the near infrared light region also improves picture quality under near-infrared LED lighting.

DOL-HDR function

The IMX385LQR supports a DOL (digital overlap) -type HDR function. This function uses a method that outputs the data for three frames with different storage times line by line instead of

frame by frame, enabling improvement of picture quality especially under low illuminance when compared to the existing multiple exposure HDR function.

Versatile interface

The IMX385LQR is equipped with two different types of output interface (low-voltage LVDS serial, MIPI CSI-2) to meet the diverse needs of customers. The low-voltage LVDS serial interface has a maximum output data rate of 445.5 Mbps/ch,

and the number of output channels can be selected from 1 ch, 2 ch, or 4 ch. The MIPI CSI-2 interface has a maximum output data rate of 742.5 Mbps/lane, and the number of output lanes can be selected from 1 lane, 2 lanes, or 4 lanes.

<Photograph 1> Sample Images at high illuminance

Condition: 450 lx F2.0 (ADC12 bit mode, 30 frame/s, Internal gain: 0 dB)



<Photograph 2> Sample Images at low illuminance

Condition: 1 lx F2.0 (ADC12 bit mode, 30 frame/s, Internal gain 30 dB + High conversion efficiency mode)



<Table 1> Device Structure

Item		IMX385LQR
Output image size		Diagonal 8.35 mm (Type 1/2) aspect ratio 16:9
Number of effective pixels		1945 (H) × 1097 (V) approx. 2.13M pixels
Unit cell size		3.75 μm (H) × 3.75 μm (V)
Optical blacks	Horizontal	Front: 4 pixels, rear: 0 pixels
	Vertical	Front: 16 pixels, rear: 0 pixels
Input drive frequency		37.125 MHz, 74.25 MHz
Output Interface		Sub-LVDS (444.5 Mbps / ch, Max. 4 ch) MIPI CSI-2 (742.5 Mbps / lane Max. 4 lane)
Package		128-pin LGA
Supply voltage V _{DD} (Typ.)		3.3 V / 1.8 V / 1.2 V

<Table 2> Image Sensor Characteristics

Item		Value	Remarks
Sensitivity (F5.6)	Typ.	2350 mV	1/30s accumulation
Saturation signal	Min.	1210 mV	T _j = 60 °C

<Table 3> Basic Drive Mode

Drive mode	Recommended number of recording pixels	Frame rate [frame/s]	ADC [bit]
All-pixel scan (12 bit)	1920 (H) × 1080 (V)	60	12
All-pixel scan (12 bit)	1920 (H) × 1080 (V)	30	12
All-pixel scan (10 bit)	1920 (H) × 1080 (V)	120	10
All-pixel scan (10 bit)	1920 (H) × 1080 (V)	60	10
All-pixel scan (10 bit)	1920 (H) × 1080 (V)	30	10

<Table 4> HDR Drive Mode

Drive mode	Recommended number of recording pixels	Frame rate (through synthesis) [frame/s]	ADC [bit]
All-pixel scan (12 bit) DOL *1 2F sequential control	1920 (H) × 1080 (V)	30	12
All-pixel scan (10 bit) DOL *1 3F sequential control	1920 (H) × 1080 (V)	30	10

*1 There are restrictions on the storage time setting values when using DOL.

*Sony reserves the right to change products and specifications without prior notice.

Cameras Applications



Automotive Driver Pilot



Live Streaming



Video Conference



Eye Tracker Biometric Detection

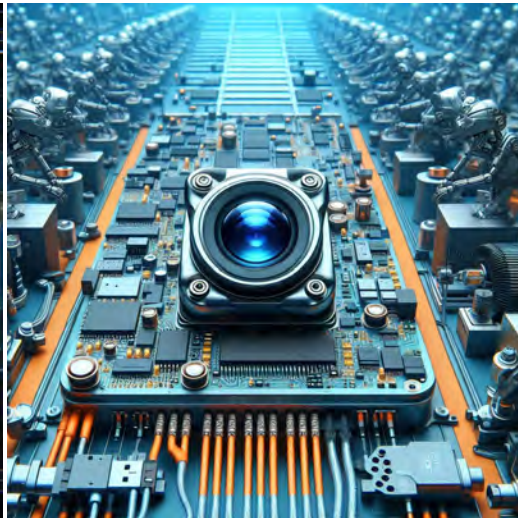

Machine Vision



Agricultural Monitor



Night Vision Security



Drone and Sports Eagle Eyes



Interactive Pet Camera



YDS CAMERA MODULE

your best camera partner

Camera Module Pinout Definition Reference Chart

OmniVision	Sony	Samsung	On-Semi	Aptina	Himax	GalaxyCore	PixArt	SmartSens	Sensors
Pin Signal		Description							
DGND GND		ground for digital circuit							
AGND		ground for analog circuit							
PCLK DCK		DVP PCLK output							
XCLR PWDN XSHUTDOWN STANDBY		power down active high with internal pull-down resistor							
MCLK XVCLK XCLK INCK		system input clock							
RESET RST		reset active low with internal pull-up resistor							
NC NULL		no connect							
SDA SIO_D SIOD		SCCB data							
SCL SIO_C SIOC		SCCB input clock							
VSYNC XVS FSYNC		DVP VSYNC output							
HREF XHS		DVP HREF output							
DOVDD		power for I/O circuit							
AFVDD		power for VCM circuit							
AVDD		power for analog circuit							
DVDD		power for digital circuit							
STROBE FSTROBE		strobe output							
FSIN		synchronize the VSYNC signal from the other sensor							
SID		SCCB last bit ID input							
ILPWM		mechanical shutter output indicator							
FREQ		frame exposure / mechanical shutter							
GPIO		general purpose inputs							
SLASEL		I2C slave address select							
AFEN		CEN chip enable active high on VCM driver IC							
MIPI Interface									
MDN0 DN0 MD0N DATA_N DMO1N		MIPI 1st data lane negative output							
MDP0 DP0 MD0P DATA_P DMO1P		MIPI 1st data lane positive output							
MDN1 DN1 MD1N DATA2_N DMO2N		MIPI 2nd data lane negative output							
MDP1 DP1 MD1P DATA2_P DMO2P		MIPI 2nd data lane positive output							
MDN2 DN2 MD2N DATA3_N DMO3N		MIPI 3rd data lane negative output							
MDP2 DP2 MD2P DATA3_P DMO3P		MIPI 3rd data lane positive output							
MDN3 DN3 MD3N DATA4_N DMO4N		MIPI 4th data lane negative output							
MDP3 DP3 MD3P DATA4_P DMO4P		MIPI 4th data lane positive output							
MCN CLKN CLK_N DCKN		MIPI clock negative output							
MCP CLKP MCP CLK_P DCKN		MIPI clock positive output							
DVP Parallel Interface									
D0 DO0 Y0		DVP data output port 0							
D1 DO1 Y1		DVP data output port 1							
D2 DO2 Y2		DVP data output port 2							
D3 DO3 Y3		DVP data output port 3							
D4 DO4 Y4		DVP data output port 4							
D5 DO5 Y5		DVP data output port 5							
D6 DO6 Y6		DVP data output port 6							
D7 DO7 Y7		DVP data output port 7							
D8 DO8 Y8		DVP data output port 8							
D9 DO9 Y9		DVP data output port 9							
D10 DO10 Y10		DVP data output port 10							
D11 DO11 Y11		DVP data output port 11							

www.YDSCAM.com sales@ydscam.com Phone (WeChat, QQ): (+86) 177 2732 6718

All rights reserved @ YingDeShun Co. Ltd. Specifications subject to change without notice.

Camera Reliability Test

Reliability Inspection Item		Testing Method	Acceptance Criteria	
Category	Item			
Environmental	Storage Temperature	High 60°C 96 Hours	Temperature Chamber	No Abnormal Situation
		Low -20°C 96 Hours	Temperature Chamber	No Abnormal Situation
	Operation Temperature	High 60°C 24 Hours	Temperature Chamber	No Abnormal Situation
		Low -20°C 24 Hours	Temperature Chamber	No Abnormal Situation
	Humidity	60°C 80% 24 Hours	Temperature Chamber	No Abnormal Situation
	Thermal Shock	High 60°C 0.5 Hours Low -20°C 0.5 Hours Cycling in 24 Hours	Temperature Chamber	No Abnormal Situation
Physical	Drop Test (Free Falling)	Without Package 60cm	10 Times on Wood Floor	Electrically Functional
		With Package 60cm	10 Times on Wood Floor	Electrically Functional
	Vibration Test	50Hz X-Axis 2mm 30min	Vibration Table	Electrically Functional
		50Hz Y-Axis 2mm 30min	Vibration Table	Electrically Functional
		50Hz Z-Axis 2mm 30min	Vibration Table	Electrically Functional
	Cable Tensile Strength Test	Loading Weight 4 kg 60 Seconds Cycling in 24 Hours	Tensile Testing Machine	Electrically Functional
Electrical	ESD Test	Contact Discharge 2 KV	ESD Testing Machine	Electrically Functional
		Air Discharge 4 KV	ESD Testing Machine	Electrically Functional
	Aging Test	On/Off 30 Seconds Cycling in 24 Hours	Power Switch	Electrically Functional
	USB Connector	On/Off 250 Times	Plug and Unplug	Electrically Functional



Camera Inspection Standard

Inspection Item		Inspection Method	Standard of Inspection		
Category	Item				
Appearance	FPC/ PCB	Color	The Naked Eye	Major Difference is Not Allowed.	
		Be Torn/Chopped	The Naked Eye	Copper Crack Exposure is Not Allowed.	
		Marking	The Naked Eye	Clear, Recognizable (Within 30cm Distance)	
	Holder	Scratches	The Naked Eye	The Inside Crack Exposure is Not Allowed	
		Gap	The Naked Eye	Meet the Height Standard	
		Screw	The Naked Eye	Make Sure Screws Are Presented (If Any)	
		Damage	The Naked Eye	The Inside Crack Exposure is Not Allowed	
	Lens	Scratch	The Naked Eye	No Effect On Resolution Standard	
		Contamination	The Naked Eye	No Effect On Resolution Standard	
		Oil Film	The Naked Eye	No Effect On Resolution Standard	
		Cover Tape	The Naked Eye	No Issue On Appearance.	
	Function	Image	No Communication	Test Board	Not Allowed
			Bright Pixel	Black Board	Not Allowed In the Image Center
Dark Pixel			White board	Not Allowed In the Image Center	
Blurry			The Naked Eye	Not Allowed	
No Image			The Naked Eye	Not Allowed	
Vertical Line			The Naked Eye	Not Allowed	
Horizontal Line			The Naked Eye	Not Allowed	
Light Leakage			The Naked Eye	Not Allowed	
Blinking Image			The Naked Eye	Not Allowed	
Bruise			Inspection Jig	Not Allowed	
Resolution			Chart	Follows Outgoing Inspection Chart Standard	
Color			The Naked Eye	No Issue	
Noise			The Naked Eye	Not Allowed	
Corner Dark			The Naked Eye	Less Than 100px By 100px	
Color Resolution			The Naked Eye	No Issue	
Dimension	Height	The Naked Eye	Follows Approval Data Sheet		
	Width	The Naked Eye	Follows Approval Data Sheet		
	Length	The Naked Eye	Follows Approval Data Sheet		
	Overall	The Naked Eye	Follows Approval Data Sheet		

YDSCAM Package Solutions

YDS Camera Module



Complete with Lens Protection Film



Tray with Grid and Space



Place Cameras on the Tray



YDSCAM Package Solutions

Full Tray of Cameras



Cover Tray with Lid

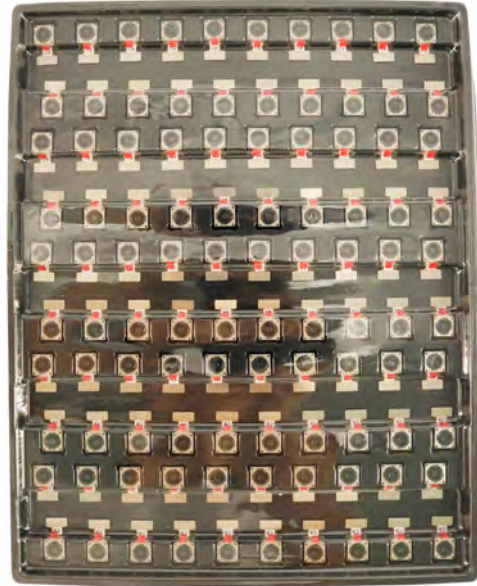

Place Tray into Anti-Static Bag



Vacuum the Anti-Static Bag



YDSCAM Package Solutions

Sealed Vacuum Anti-Static Bag with Labels

1. Model and Description 2. Quantity 3. Manufacturing Date Code 4. Caution



YDSCAM Package Solutions

Place Foam Sheets Between Tray Bags



Foam Sheets are Larger Than Trays



Place Foam Sheets and Trays into Box



Foam Sheets are Tightly Fitting in Box



Seal the Carbon Box



Label the Carbon Shipping Box





YDSCAM Package Solutions

USB Camera Module

Complete with Lens Protection Film



Place Camera Sample into Anti-Static Bag

Place USB Cameras into Tray



Seal the Tray with Anti-Static Bag

Label the Carbon Shipping Box



YDSCAM Package Solutions

Place Camera Sample into Anti-Static Bag



Place Connectors into Anti-Static Bag



Label the Sample Bags



Place Connectors into Reel



Place Samples into the Carbon Box



Place Connectors into the Carbon Box





YDS CAMERA MODULE

your best camera partner

Company YDSCAM

YingDeShun Co. Ltd. (YDS) was established in 2017, a next-generation technology driven manufacturer specialized in research, design, and produce of audio and video products. YDS is occupying 20,000 square feet automated plants with 100 employees of annual throughput 30,000,000 units cameras.

YDS provides OEM, ODM design, contract manufacturing, and builds the camera products. You may provide the requirements to us, even with a hand draft, our sales and engineering work together to meet your needs. We consider ourselves your last-term partner in developing practical and innovative solutions.

Our team covers everything from initial concept development to mass produced product. YDS specializes in customized camera design, raw material, electronic engineering, firmware/software development, product testing, and packing design. Our experienced strategic supply systems offer a robust and dependable manufacturing capacity for orders of various sizes.

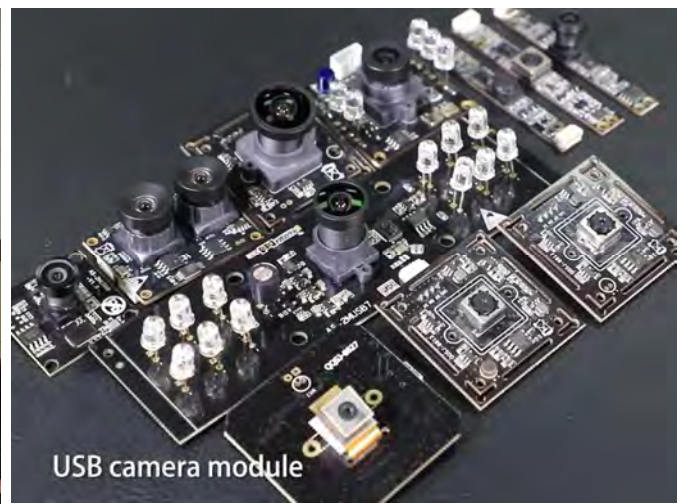

Limited Warranty

YDS provides the following limited warranty if you purchased the Product(s) directly from YDS company or from YDS's website www.YDSCAM.com. Product(s) purchased from other sellers or sources are not covered by this Limited Warranty. YDS guarantees that the Product(s) will be free from defects in materials and workmanship under normal use for a period of one (1) year from the date you receive the product ("Warranty Period").

For all Product(s) that contain or develop material defects in materials or workmanship during the Warranty Period, YDS will, at its sole option, either: (i) repair the Product(s); (ii) replace the Product(s) with a new or refurbished Product(s) (replacement Product(s) being of identical model or functional equivalent); or (iii) provide you a refund of the price you paid for the Product(s).

This Limited Warranty of YDS is solely limited to repair and/or replacement on the terms set forth above. YDS is not reliable or responsible for any subsequent events.



www.YDSCAM.com sales@ydscam.com Phone (WeChat, QQ): (+86) 177 2732 6718

All rights reserved @ YingDeShun Co. Ltd. Specifications subject to change without notice.



YDS CAMERA MODULE

your best camera partner

YDS Strength

Powerful Factory



Professional Service



Promised Delivery



www.YDSCAM.com sales@ydscam.com Phone (WeChat, QQ): (+86) 177 2732 6718

All rights reserved @ YingDeShun Co. Ltd. Specifications subject to change without notice.